



84000

FEATURES:

Wall hugger power recliners with full footrest. Manual adjustable headrest on all items. Seat cushions with shaped foam + 1" layer of memory foam on top; arm with memory foam. Stitching: Small thread in fabric & large flat thread in leather.

OPTIONS

*Motorized headrest: \$220 ea. *N/A on stationary items.

*Motorized headrest \$220 +** Lumbar support & heated back \$275= \$490 ea. (Only on recliner items with arm).

**Attn: with BACK 2: available only on 30"seat widths | with BACK 4: available only with 22" seat depth.

Battery Pack: \$220/ea.

Foam: Extra firm \$25/seat.

Arm 7: Choice of with or without "Wood Insert" in arm. If with wood insert, specify colour.

Leg on 7.25 Arm: Metal: LG064 square (chrome) or LG196 cylinder (Chrome or Matte Black). Wood: LG008 (specify color).

Seat Depth: 20" or 22".

HOME THEATRE Configurations

For Accessories, Cup holders & Configuration details, see page attached.

Accessory Dock : \$60 ea.

Cup Holders: Metal: \$65 ea. | LED lighted Cup Holder: \$65 ea. | *LED lighted Cup Holder with (1 or 2 motor) controls: \$90 ea.

*LED Light strip under seat: \$40/seat.

Description	L x D x H	Leather						Fabric		
		10	20	30 Bronx Hugo Illusion Tucson Utah Vintage Wild Laredo Yukon	40 Cavallo Princess Santiago Sensation Sunset Trina Victoria	50 Bull Cassiope Dublin	60 Caress Ultrasued	A	B COM	C alta
001 CHAIR	38x40x33/40	2675	2825	2980	3130	3280	3435	2185	2240	2300
002 LOVESEAT	62x40x33/40	3840	4010	4180	4345	4515	4680	3080	3180	3275
003 SOFA	86x40x33/40	4635	4865	5100	5330	5560	5795	3730	3865	4000
005 LOUNGE CHAIR RIGHT ARM	31x62x33/40	2515	2620	2720	2825	2930	3035	2010	2105	2200
009 ARMLESS LOVESEAT	47x40x33/40	2690	2800	2915	3025	3140	3250	2145	2250	2355
011 LOUNGE CHAIR LEFT ARM	31x62x33/40	2515	2620	2720	2825	2930	3035	2010	2105	2200
012 LOVESEAT LEFT ARM	54x40x33/40	3315	3460	3600	3745	3890	4035	2640	2740	2835
017 DOUBLE CHAIR	45x40x33/40	2820	2970	3120	3275	3425	3580	2260	2355	2450
021 APARTMENT SOFA NO ARM	61x40x33/40	3040	3180	3315	3450	3585	3720	2370	2500	2625
040 ARMLESS SOFA	71x40x33/40	3500	3650	3800	3955	4105	4260	2760	2900	3035
041 RECLINING CHAIR LEFT ARM	31x40x33/40	2690	2785	2880	2980	3075	3170	2290	2360	2435
042 RECLINING CHAIR RIGHT ARM	31x40x33/40	2690	2785	2880	2980	3075	3170	2290	2360	2435
044 RECLINER CHAIR	38x40x33/40	3240	3385	3530	3675	3820	3960	2740	2795	2850
051 ARMLESS CHAIR	23.5x40x33/40	1555	1635	1715	1795	1875	1955	1200	1275	1345
052 SOFA LEFT ARM	78x40x33/40	4100	4275	4450	4625	4800	4980	3260	3400	3545
053 SOFA RIGHT ARM	78x40x33/40	4100	4275	4450	4625	4800	4980	3260	3400	3545
056 CHAIR RIGHT ARM	31x40x33/40	2155	2240	2330	2420	2505	2595	1700	1770	1840
057 CHAIR LEFT ARM	31x40x33/40	2155	2240	2330	2420	2505	2595	1700	1770	1840



84000

FEATURES:

Wall hugger power recliners with full footrest. Manual adjustable headrest on all items. Seat cushions with shaped foam + 1" layer of memory foam on top; arm with memory foam. Stitching: Small thread in fabric & large flat thread in leather.

OPTIONS

*Motorized headrest: \$220 ea. *N/A on stationary items.

*Motorized headrest \$220 +** Lumbar support & heated back \$275= \$490 ea. (Only on recliner items with arm).

**Attn: with BACK 2: available only on 30"seat widths | with BACK 4: available only with 22" seat depth.

Battery Pack: \$220/ea.

Foam: Extra firm \$25/seat.

Arm 7: Choice of with or without "Wood Insert" in arm. If with wood insert, specify colour.

Leg on 7.25 Arm: Metal: LG064 square (chrome) or LG196 cylinder (Chrome or Matte Black). Wood: LG008 (specify color).

Seat Depth: 20" or 22".

HOME THEATRE Configurations

For Accessories, Cup holders & Configuration details, see page attached.

Accessory Dock : \$60 ea.

Cup Holders: Metal: \$65 ea. | LED lighted Cup Holder: \$65 ea. | *LED lighted Cup Holder with (1 or 2 motor) controls: \$90 ea.

*LED Light strip under seat: \$40/seat.

Description	L x D x H	Leather						Fabric		
		10	20	30 Bronx Hugo Illusion Tucson Utah Vintage Wild Laredo Yukon	40 Cavallo Princess Santiago Sensation Sunset Trina Victoria	50 Bull Cassiope Dublin	60 Caress Ultrasued	A	B COM	C alta
061 LOVESEAT RIGHT ARM	54x40x33/40	3315	3460	3600	3745	3890	4035	2640	2740	2835
071 ARMLESS RECLINING CHAIR	23.5x40x33/40	2090	2185	2280	2380	2475	2570	1795	1880	1970
095 APARTMENT SOFA	76x40x33/40	4170	4385	4600	4820	5035	5250	3345	3465	3585
096 APARTMENT SOFA LEFT ARM	68x40x33/40	3660	3825	3995	4160	4330	4500	2865	2985	3105
097 APARTMENT SOFA RIGHT ARM	68x40x33/40	3660	3825	3995	4160	4330	4500	2865	2985	3105
124 STORAGE OTTOMAN	30x22x17	1065	1105	1145	1185	1225	1265	930	945	960
138 STRAIGHT ARM	10x36x24.5	595	650	705	760	820	875	500	530	560
159 WEDGE STORAGE	11/27x36x24.5	1080	1120	1160	1200	1240	1280	825	850	875
160 STRAIGHT STORAGE	11x36x24.5	1020	1075	1130	1185	1240	1300	785	810	835
165 DOUBLE RECLINING CHAIR	45x40x33/40	3380	3520	3665	3810	3955	4100	2850	2955	3060
169 DOUBLE RECLINING CHAIR LEFT ARM	38x40x33/40	2840	2960	3080	3200	3320	3440	2385	2480	2580
170 DOUBLE RECLINING CHAIR RIGHT ARM	38x40x33/40	2840	2960	3080	3200	3320	3440	2385	2480	2580
171 ARMLESS DOUBLE RECLINING CHAIR	30.5x40x33/40	2240	2330	2420	2505	2595	2680	1900	1985	2075
173 DOUBLE LOUNGE CHAIR LEFT ARM	38x62x33/40	2720	2860	2995	3130	3265	3400	2185	2315	2440
174 DOUBLE LOUNGE CHAIR RIGHT ARM	38x62x33/40	2720	2860	2995	3130	3265	3400	2185	2315	2440
175 DOUBLE CHAIR LEFT ARM	38x40x33/40	2280	2395	2505	2620	2730	2840	1835	1930	2025
176 DOUBLE CHAIR RIGHT ARM	38x40x33/40	2280	2395	2505	2620	2730	2840	1835	1930	2025
177 ARMLESS DOUBLE CHAIR	30.5x40x33/40	1680	1785	1890	1995	2100	2200	1305	1400	1500



84000

FEATURES:

Wall hugger power recliners with full footrest. Manual adjustable headrest on all items. Seat cushions with shaped foam + 1" layer of memory foam on top; arm with memory foam. Stitching: Small thread in fabric & large flat thread in leather.

OPTIONS

*Motorized headrest: \$220 ea. *N/A on stationary items.

*Motorized headrest \$220 +** Lumbar support & heated back \$275= \$490 ea. (Only on recliner items with arm).

**Attn: with BACK 2: available only on 30"seat widths | with BACK 4: available only with 22" seat depth.

Battery Pack: \$220/ea.

Foam: Extra firm \$25/seat.

Arm 7: Choice of with or without "Wood Insert" in arm. If with wood insert, specify colour.

Leg on 7.25 Arm: Metal: LG064 square (chrome) or LG196 cylinder (Chrome or Matte Black). Wood: LG008 (specify color).

Seat Depth: 20" or 22".

HOME THEATRE Configurations

For Accessories, Cup holders & Configuration details, see page attached.

Accessory Dock : \$60 ea.

Cup Holders: Metal: \$65 ea. | LED lighted Cup Holder: \$65 ea. | *LED lighted Cup Holder with (1 or 2 motor) controls: \$90 ea.

*LED Light strip under seat: \$40/seat.

Description	L x D x H	Leather						Fabric		
		10	20	30 Bronx Hugo Illusion Tucson Utah Vintage Wild Laredo Yukon	40 Cavallo Princess Santiago Sensation Sunset Trina Victoria	50 Bull Cassiope Dublin	60 Caress Ultrasued	A	B COM	C alta
190 SMALL WEDGE STORAGE	11/21x36x24.5	1020	1075	1130	1185	1240	1300	785	810	835
226 RECLINING LOUNGE CHAIR	38x62x33/40	3780	3880	3985	4090	4195	4300	3240	3340	3435
236 RECLINING LOUNGE CHAIR LEFT ARM	31x62x33/40	3180	3280	3385	3490	3595	3700	2745	2840	2940
237 RECLINING LOUNGE CHAIR RIGHT ARM	31x62x33/40	3180	3280	3385	3490	3595	3700	2745	2840	2940
238 RECLINING DBL LOUNGE CHAIR L-ARM	38x62x33/40	3385	3520	3660	3795	3930	4065	2865	2995	3120
239 RECLINING DBL LOUNGE CHAIR R-ARM	38x62x33/40	3385	3520	3660	3795	3930	4065	2865	2995	3120
240 RECLINING DBL LOUNGE CHAIR NO ARM	30.5x62x33/40	2785	2920	3060	3195	3330	3465	2380	2505	2635
242 RECLING LOUNGE CHAIR NO ARM	23.5x62x33/40	2580	2680	2785	2890	2995	3100	2250	2345	2440
248 RECLINING DBL LOUNGE CHAIR	45x62x33/40	3985	4120	4260	4395	4530	4665	3355	3480	3610
V51 WINE GLASS HOLDER	3.5 x 5.5 x 6.5	60	60	60	60	60	60	60	60	60
V52 PLASTIC SWIVEL TRAY	13 3/8 x 9 5/8	60	60	60	60	60	60	60	60	60
V53 WOOD IMITATION SWIVEL TRAY	19 x 10	100	100	100	100	100	100	100	100	100
V54 TABLET HOLDER	4.5 x 8 x 10	65	65	65	65	65	65	65	65	65
V55 FLEXIBLE SHAFT LIGHT	1.5x5x14 pli�/bent	60	60	60	60	60	60	60	60	60



EXECUTIVE Jaymar

HOME THEATRE COLLECTION

TO CONFIGURE YOUR CHAIR, YOU MUST SELECT 1 BACK, 1 SEAT AND 1 ARM.

Ex: Model # 84 211

84 2 1 1
BACK SEAT ARM



BACK SELECTION



BACK 1
WITH MANUAL HEADREST
OR ELECTRIC *

*Optional Lumbar Support & Heated Back, available on :

- Seat Width: 23" or 30"
- Seat Depth: 20" or 22"



BACK 2
WITH MANUAL HEADREST
OR ELECTRIC *

*Optional Lumbar Support & Heated Back, available on :

- Seat Width: **30"** wide only
- Seat Depth: 20" or 22"



BACK 4
WITH MANUAL HEADREST
OR ELECTRIC *

*Optional Lumbar Support & Heated Back, available on :

- Seat Width: 23" or 30"
- Seat Depth: **22"** only

SEAT



SEAT 1
FULL LEG POWER RECLINER SEAT

ARM SELECTION, all 7,25" wide



ARM 1

ARM 6

ARM 7

ARM 8

ARM 9

ITEM 138 STRAIGHT CENTER ARM



ARM C1

ARM C6

ARM C7

ARM C8

ARM C9

*Available in straight storage (160), wedge storage (159), and small wedge storage (190).

SPECIFICATIONS

- MANUAL ADJUSTABLE HEADREST OR ELECTRIC HEADREST
- FULL LEG POWER RECLINER
- WALL HUGGER MECHANISM
- SHAPED FOAM & MEMORY FOAM
- LARGE FLAT THREAD FOR COVERS IN LEATHER



BACK & SEAT WIDTH AVAILABLE IN 23" OR 30"



SEAT DEPTH AVAILABLE IN 20" OR 22"



ACCESSORIES

Accessory Dock

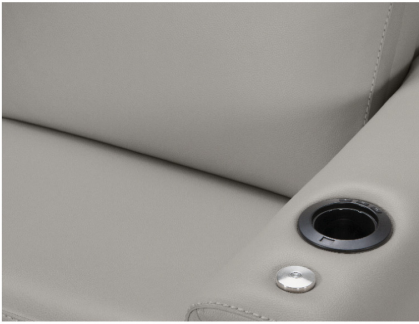

Wine Glass Holder



LED Lamp



Tablet Device Holder



Swivel Tray Table
Plastic finish



Swivel Tray Table
Wood finish - Choice of color



Items 138-159-160-190 and regular arm.

Accessory docks and cups are Optional.

Please specify on which arms you want the accessory docks and cup holders.

NB: Item 138-159-160-190 are unfinished on the sides, must be used between 2 seats.

Each storage item has 2 USB ports and one electrical outlet inside the storage.

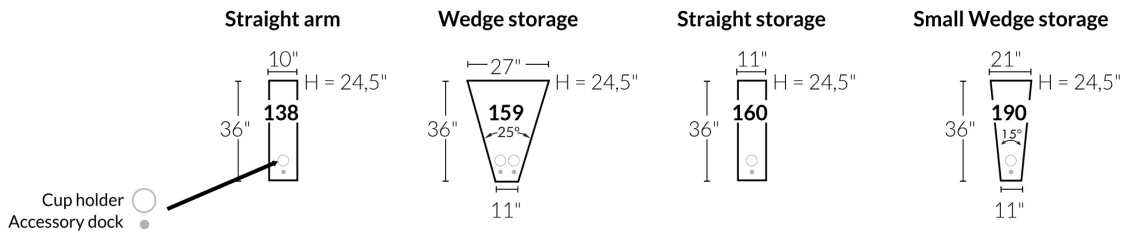

CUP HOLDERS

Metallic - Matte black, silver or brown



LED illuminated - with or without control button (1 or 2 motors)



LED lighted Cupholder

LED lighted Cupholder with single motor control, USB port and LED baserail.

LED lighted Cupholder with double motor control, USB port and LED baserail.

N.A. with optional lumbar support & heated back.

N.A. with optional lumbar support & heated back.



Jayman
HOME THEATRE COLLECTION

SPECIFICATIONS

- Ⓐ 40" Total Height
- Ⓑ 33" Height headrest down
- Ⓒ 19,5" Seat height
- Ⓓ 65" Depth fully reclined
- Ⓔ 20" or 22" Seat depth
- Ⓕ 37,5" Depth with headrest up
- Ⓖ 24,5" Arm Height
- Ⓗ 7,25" Arm Width

Our product is hand-made and minor variations can occur.

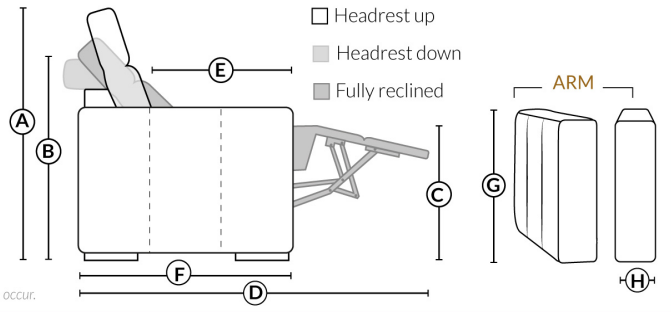

23" SEAT WIDTH

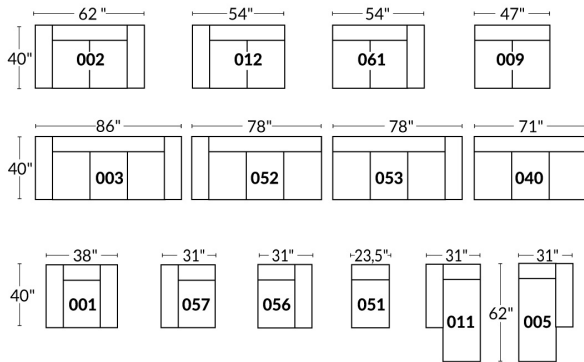

Power recliner Items

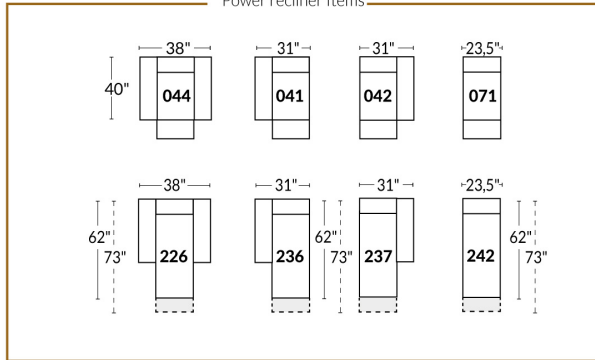

30" SEAT WIDTH

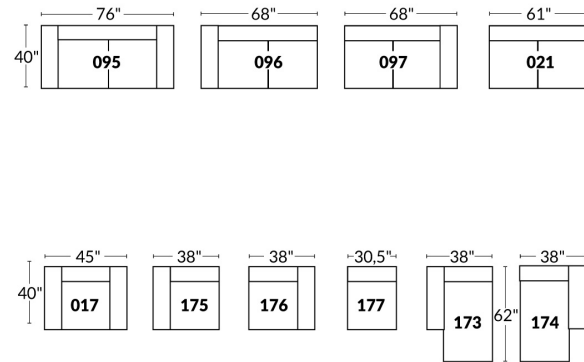

Power recliner Items

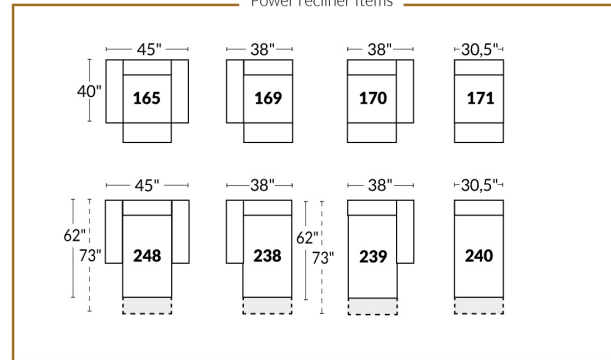

Others

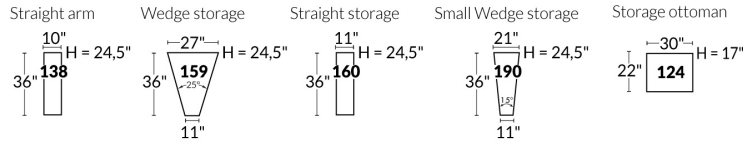

23" EXAMPLES

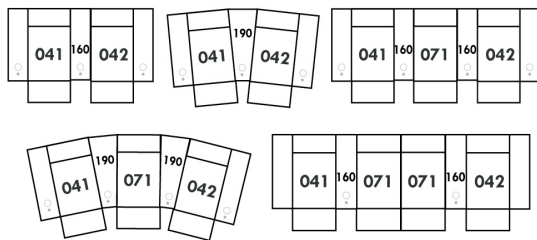

30" EXAMPLES

