



84000

FEATURES:

Wall hugger power recliners with full footrest. Manual adjustable headrest on all items. Seat cushions with shaped foam + 1" layer of memory foam on top; arm with memory foam. Stitching: Small thread in fabric & large flat thread in leather.

OPTIONS

*Motorized headrest: \$185 ea. *N/A on stationary items.

*Motorized headrest \$185 +** Lumbar support & heated back \$230= \$410 ea. (Only on recliner items with arm).

**Attn: with BACK 2: available only on 30"seat widths | with BACK 4: available only with 22" seat depth.

Battery Pack: \$185/ea.

Foam: Extra firm \$20/seat.

Arm 7: Choice of with or without "Wood Insert" in arm. If with wood insert, specify colour.

Leg on 7.25 Arm: Metal: LG064 square (chrome) or LG196 cylinder (Chrome or Matte Black). Wood: LG008 (specify color).

Seat Depth: 20" or 22".

HOME THEATRE Configurations

For Accessories, Cup holders & Configuration details, see page attached.

Accessory Dock : \$40 ea.

Cup Holders: Metal: \$50 ea. | LED lighted Cup Holder: \$50 ea. | *LED lighted Cup Holder with (1 or 2 motor) controls: \$65 ea.

*LED Light strip under seat: \$30/seat.

Description	L x D x H	Leather						Fabric		
		10	20	30 Bronx Hugo Illusion Tucson Utah Vintage Wild Laredo Yukon	40 Cavallo Princess Santiago Sensation Sunset Trina Victoria	50 Bull Cassiope Dublin	60 Caress Ultrasued	A	B COM	C alta
001 CHAIR	38x40x33/40	2245	2345	2450	2550	2650	2755	1820	1875	1925
002 LOVESEAT	62x40x33/40	3205	3335	3465	3595	3725	3855	2585	2670	2755
003 SOFA	86x40x33/40	3880	4050	4215	4385	4555	4725	3115	3215	3320
005 LOUNGE CHAIR RIGHT ARM	31x62x33/40	2100	2170	2245	2320	2390	2465	1675	1745	1810
009 ARMLESS LOVESEAT	47x40x33/40	2250	2330	2410	2490	2570	2645	1770	1860	1950
011 LOUNGE CHAIR LEFT ARM	31x62x33/40	2100	2170	2245	2320	2390	2465	1675	1745	1810
012 LOVESEAT LEFT ARM	54x40x33/40	2755	2865	2980	3095	3205	3320	2200	2285	2370
017 DOUBLE CHAIR	45x40x33/40	2355	2465	2580	2690	2805	2920	1900	1970	2035
021 APARTMENT SOFA NO ARM	61x40x33/40	2540	2650	2765	2880	2990	3105	1985	2080	2180
040 ARMLESS SOFA	71x40x33/40	2910	3040	3170	3300	3430	3560	2320	2420	2520
041 RECLINING CHAIR LEFT ARM	31x40x33/40	2240	2325	2410	2495	2580	2665	1905	1945	1985
042 RECLINING CHAIR RIGHT ARM	31x40x33/40	2240	2325	2410	2495	2580	2665	1905	1945	1985
044 RECLINER CHAIR	38x40x33/40	2705	2805	2905	3010	3110	3210	2280	2335	2390
051 ARMLESS CHAIR	23.5x40x33/40	1290	1345	1405	1460	1515	1575	1005	1065	1125
052 SOFA LEFT ARM	78x40x33/40	3410	3560	3715	3865	4020	4170	2720	2825	2935
053 SOFA RIGHT ARM	78x40x33/40	3410	3560	3715	3865	4020	4170	2720	2825	2935
056 CHAIR RIGHT ARM	31x40x33/40	1795	1865	1940	2015	2085	2160	1425	1495	1560
057 CHAIR LEFT ARM	31x40x33/40	1795	1865	1940	2015	2085	2160	1425	1495	1560

84000

FEATURES:

Wall hugger power recliners with full footrest. Manual adjustable headrest on all items. Seat cushions with shaped foam + 1" layer of memory foam on top; arm with memory foam. Stitching: Small thread in fabric & large flat thread in leather.

OPTIONS

*Motorized headrest: \$185 ea. *N/A on stationary items.

*Motorized headrest \$185 +** Lumbar support & heated back \$230= \$410 ea. (Only on recliner items with arm).

**Attn: with BACK 2: available only on 30"seat widths | with BACK 4: available only with 22" seat depth.

Battery Pack: \$185/ea.

Foam: Extra firm \$20/seat.

Arm 7: Choice of with or without "Wood Insert" in arm. If with wood insert, specify colour.

Leg on 7.25 Arm: Metal: LG064 square (chrome) or LG196 cylinder (Chrome or Matte Black). Wood: LG008 (specify color).

Seat Depth: 20" or 22".

HOME THEATRE Configurations

For Accessories, Cup holders & Configuration details, see page attached.

Accessory Dock : \$40 ea.

Cup Holders: Metal: \$50 ea. | LED lighted Cup Holder: \$50 ea. | *LED lighted Cup Holder with (1 or 2 motor) controls: \$65 ea.

*LED Light strip under seat: \$30/seat.

Description	L x D x H	Leather						Fabric		
		10	20	30 Bronx Hugo Illusion Tucson Utah Vintage Wild Laredo Yukon	40 Cavallo Princess Santiago Sensation Sunset Trina Victoria	50 Bull Cassiope Dublin	60 Caress Ultrasued	A	B COM	C alta
061 LOVESEAT RIGHT ARM	54x40x33/40	2755	2865	2980	3095	3205	3320	2200	2285	2370
071 ARMLESS RECLINING CHAIR	23.5x40x33/40	1750	1810	1875	1935	1995	2060	1490	1555	1625
095 APARTMENT SOFA	76x40x33/40	3490	3650	3815	3980	4145	4310	2795	2900	3010
096 APARTMENT SOFA LEFT ARM	68x40x33/40	3055	3180	3300	3425	3550	3675	2400	2500	2600
097 APARTMENT SOFA RIGHT ARM	68x40x33/40	3055	3180	3300	3425	3550	3675	2400	2500	2600
124 STORAGE OTTOMAN	30x22x17	885	905	930	950	975	995	775	800	820
138 STRAIGHT ARM	10x36x24.5	495	535	575	615	650	690	420	440	455
159 WEDGE STORAGE	11/27x36x24.5	885	920	950	985	1020	1055	695	715	730
160 STRAIGHT STORAGE	11x36x24.5	855	885	910	940	970	995	660	680	705
165 DOUBLE RECLINING CHAIR	45x40x33/40	2820	2935	3050	3160	3275	3385	2375	2450	2520
169 DOUBLE RECLINING CHAIR LEFT ARM	38x40x33/40	2365	2455	2545	2635	2725	2815	1985	2075	2165
170 DOUBLE RECLINING CHAIR RIGHT ARM	38x40x33/40	2365	2455	2545	2635	2725	2815	1985	2075	2165
171 ARMLESS DOUBLE RECLINING CHAIR	30.5x40x33/40	1875	1930	1985	2040	2100	2155	1570	1635	1705
173 DOUBLE LOUNGE CHAIR LEFT ARM	38x62x33/40	2275	2375	2475	2580	2680	2780	1820	1910	2005
174 DOUBLE LOUNGE CHAIR RIGHT ARM	38x62x33/40	2275	2375	2475	2580	2680	2780	1820	1910	2005
175 DOUBLE CHAIR LEFT ARM	38x40x33/40	1890	1990	2095	2195	2295	2400	1530	1600	1675
176 DOUBLE CHAIR RIGHT ARM	38x40x33/40	1890	1990	2095	2195	2295	2400	1530	1600	1675
177 ARMLESS DOUBLE CHAIR	30.5x40x33/40	1410	1485	1555	1630	1705	1775	1085	1150	1210



84000

FEATURES:

Wall hugger power recliners with full footrest. Manual adjustable headrest on all items. Seat cushions with shaped foam + 1" layer of memory foam on top; arm with memory foam. Stitching: Small thread in fabric & large flat thread in leather.

OPTIONS

*Motorized headrest: \$185 ea. *N/A on stationary items.

*Motorized headrest \$185 +** Lumbar support & heated back \$230= \$410 ea. (Only on recliner items with arm).

**Attn: with BACK 2: available only on 30"seat widths | with BACK 4: available only with 22" seat depth.

Battery Pack: \$185/ea.

Foam: Extra firm \$20/seat.

Arm 7: Choice of with or without "Wood Insert" in arm. If with wood insert, specify colour.

Leg on 7.25 Arm: Metal: LG064 square (chrome) or LG196 cylinder (Chrome or Matte Black). Wood: LG008 (specify color).

Seat Depth: 20" or 22".

HOME THEATRE Configurations

For Accessories, Cup holders & Configuration details, see page attached.

Accessory Dock : \$40 ea.

Cup Holders: Metal: \$50 ea. | LED lighted Cup Holder: \$50 ea. | *LED lighted Cup Holder with (1 or 2 motor) controls: \$65 ea.

*LED Light strip under seat: \$30/seat.

Description	L x D x H	Leather						Fabric		
		10	20	30 Bronx Hugo Illusion Tucson Utah Vintage Wild Laredo Yukon	40 Cavallo Princess Santiago Sensation Sunset Trina Victoria	50 Bull Cassiope Dublin	60 Caress Ultrasued	A	B COM	C alta
190 SMALL WEDGE STORAGE	11/21x36x24.5	855	885	910	940	970	995	660	680	705
226 RECLINING LOUNGE CHAIR	38x62x33/40	3060	3135	3205	3280	3355	3425	2580	2645	2715
236 RECLINING LOUNGE CHAIR LEFT ARM	31x62x33/40	2570	2640	2715	2790	2860	2935	2160	2230	2295
237 RECLINING LOUNGE CHAIR RIGHT ARM	31x62x33/40	2570	2640	2715	2790	2860	2935	2160	2230	2295
238 RECLINING DBL LOUNGE CHAIR L-ARM	38x62x33/40	2750	2850	2950	3055	3155	3255	2300	2390	2485
239 RECLINING DBL LOUNGE CHAIR R-ARM	38x62x33/40	2750	2850	2950	3055	3155	3255	2300	2390	2485
240 RECLINING DBL LOUNGE CHAIR NO ARM	30.5x62x33/40	2255	2360	2460	2560	2665	2765	1885	1975	2065
242 RECLING LOUNGE CHAIR NO ARM	23.5x62x33/40	2075	2150	2225	2295	2370	2445	1745	1810	1880
248 RECLINING DBL LOUNGE CHAIR	45x62x33/40	3240	3340	3445	3545	3645	3750	2720	2810	2900
V51 WINE GLASS HOLDER	3.5 x 5.5 x 6.5	40	40	40	40	40	40	40	40	40
V52 PLASTIC SWIVEL TRAY	13 3/8 x 9 5/8	40	40	40	40	40	40	40	40	40
V53 WOOD IMITATION SWIVEL TRAY	19 x 10	70	70	70	70	70	70	70	70	70
V54 TABLET HOLDER	4.5 x 8 x 10	50	50	50	50	50	50	50	50	50
V55 FLEXIBLE SHAFT LIGHT	1.5x5x14 pli�/bent	40	40	40	40	40	40	40	40	40



EXECUTIVE Jaymar

HOME THEATRE COLLECTION

TO CONFIGURE YOUR CHAIR, YOU MUST SELECT 1 BACK, 1 SEAT AND 1 ARM.

Ex: Model # 84 211

84 2 1 1
BACK SEAT ARM



BACK SELECTION



BACK 1
WITH MANUAL HEADREST
OR ELECTRIC *

*Optional Lumbar Support & Heated Back, available on :

- Seat Width: 23" or 30"
- Seat Depth: 20" or 22"



BACK 2
WITH MANUAL HEADREST
OR ELECTRIC *

*Optional Lumbar Support & Heated Back, available on :

- Seat Width: **30"** wide only
- Seat Depth: 20" or 22"



BACK 4
WITH MANUAL HEADREST
OR ELECTRIC *

*Optional Lumbar Support & Heated Back, available on :

- Seat Width: 23" or 30"
- Seat Depth: **22"** only

SEAT



SEAT 1
FULL LEG POWER RECLINER SEAT

ARM SELECTION, all 7,25" wide



ARM 1

ARM 6

ARM 7

ARM 8

ARM 9

ITEM 138 STRAIGHT CENTER ARM



ARM C1

ARM C6

ARM C7

ARM C8

ARM C9

*Available in straight storage (160), wedge storage (159), and small wedge storage (190).

SPECIFICATIONS

- MANUAL ADJUSTABLE HEADREST OR ELECTRIC HEADREST
- FULL LEG POWER RECLINER
- WALL HUGGER MECHANISM
- SHAPED FOAM & MEMORY FOAM
- LARGE FLAT THREAD FOR COVERS IN LEATHER



BACK & SEAT WIDTH AVAILABLE IN 23" OR 30"



30"



23"



SEAT DEPTH AVAILABLE IN 20" OR 22"



20"



22"



ACCESSORIES

Accessory Dock

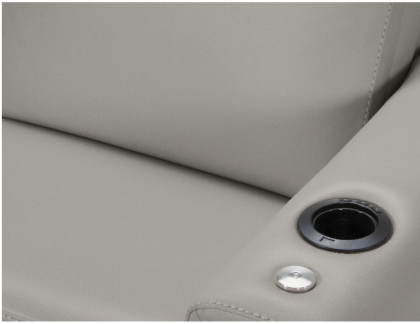

Wine Glass Holder



LED Lamp



Tablet Device Holder



Swivel Tray Table
Plastic finish



Swivel Tray Table
Wood finish - Choice of color



Items 138-159-160-190 and regular arm.

Accessory docks and cups are Optional.

Please specify on which arms you want the accessory docks and cup holders.

NB: Item 138-159-160-190 are unfinished on the sides, must be used between 2 seats.

Each storage item has 2 USB ports and one electrical outlet inside the storage.

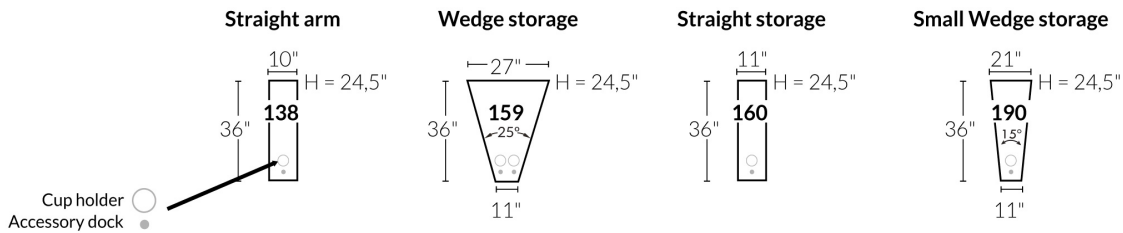

CUP HOLDERS

Metallic - Matte black, silver or brown



LED illuminated - with or without control button (1 or 2 motors)



LED lighted Cupholder

LED lighted Cupholder with single motor control, USB port and LED baserail.

LED lighted Cupholder with double motor control, USB port and LED baserail.

N.A. with optional lumbar support & heated back.

N.A. with optional lumbar support & heated back.



Jayman
HOME THEATRE COLLECTION

SPECIFICATIONS

- Ⓐ 40" Total Height
- Ⓑ 33" Height headrest down
- Ⓒ 19,5" Seat height
- Ⓓ 65" Depth fully reclined
- Ⓔ 20" or 22" Seat depth
- Ⓕ 37,5" Depth with headrest up
- Ⓖ 24,5" Arm Height
- Ⓗ 7,25" Arm Width

Our product is hand-made and minor variations can occur.

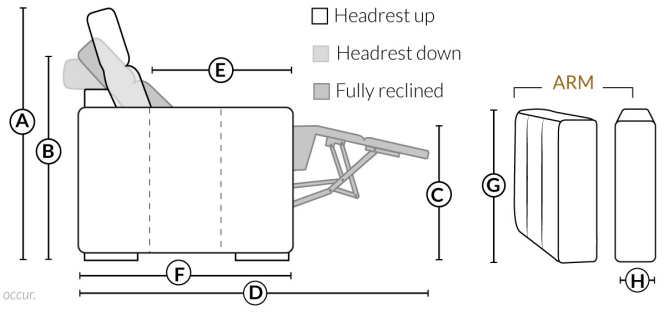

23" SEAT WIDTH

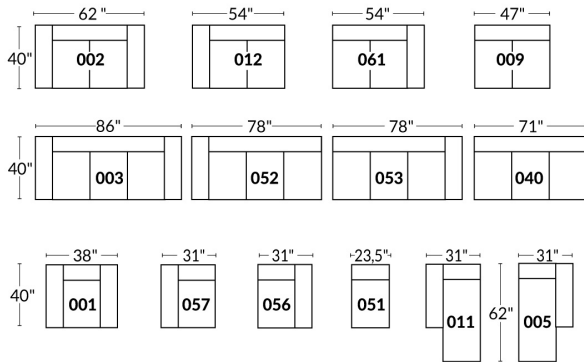

Power recliner Items

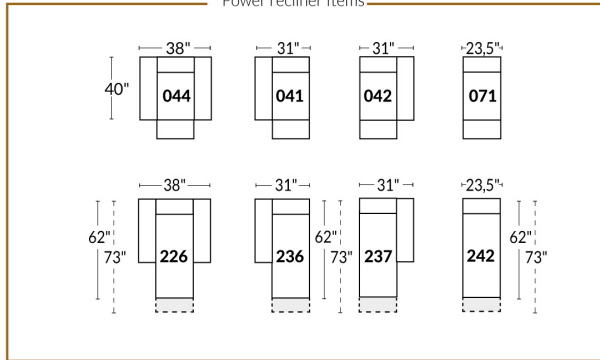

30" SEAT WIDTH

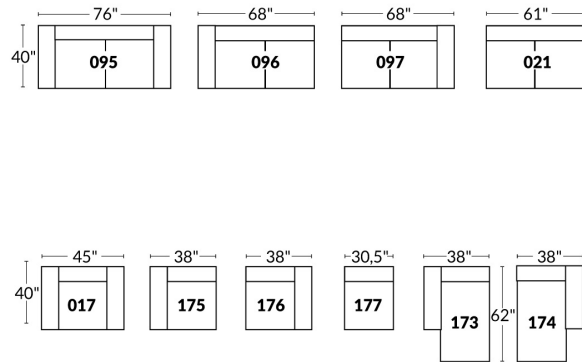

Power recliner Items

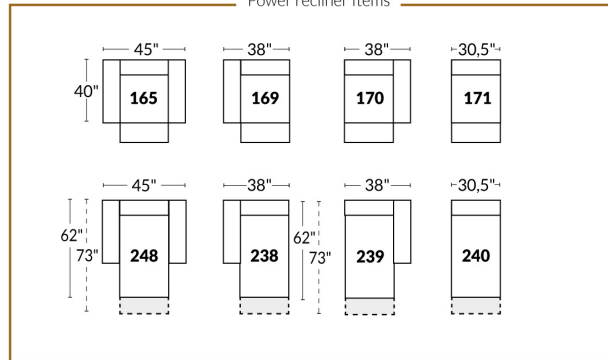

Others

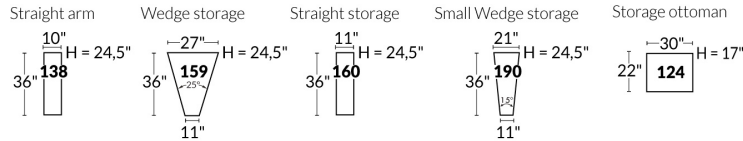

23" EXAMPLES

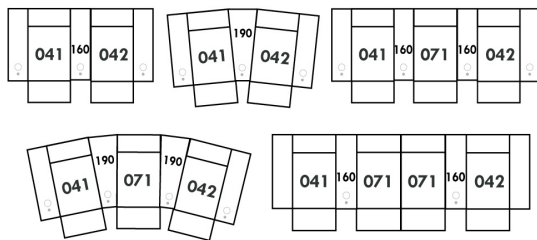

30" EXAMPLES

